

TPR

Thermally Protected Resistor

TPR10 Series



Description

Thermally Protected Resistor (TPR) is an unique type of Power Resistor, with Over Temp. and Over Current Protections. TPR is a type of power resistor, where Alloy Thermal-Link (ATCO) and Fusible Wirewound Resistor (RXF) are in series encapsulated in a ceramic case with silicone cement.

TPR is widely used in products such as power supply, office appliances, converter.

SETsafe | SETfuse TPR has the same physical size as ordinary ceramic resistor while additionally providing fault current protection. TPR can also effectively protect against the damages to devices & equipment, caused by continuous heat dissipations by ceramic resistors due to fault currents. TPR10 series Rated Resistance from 1 Ω to 100 Ω, complies with RoHS and REACH.

Features

- Over Temp. Protection
- Over Current Protection
- Small Fault Current Protection
- Inrush Current Protection
- RoHS & REACH Compliant

Applications

- Power Supplies
- Office Appliances
- Converter

Customization

- Leads Forming Types

Structure Diagrams

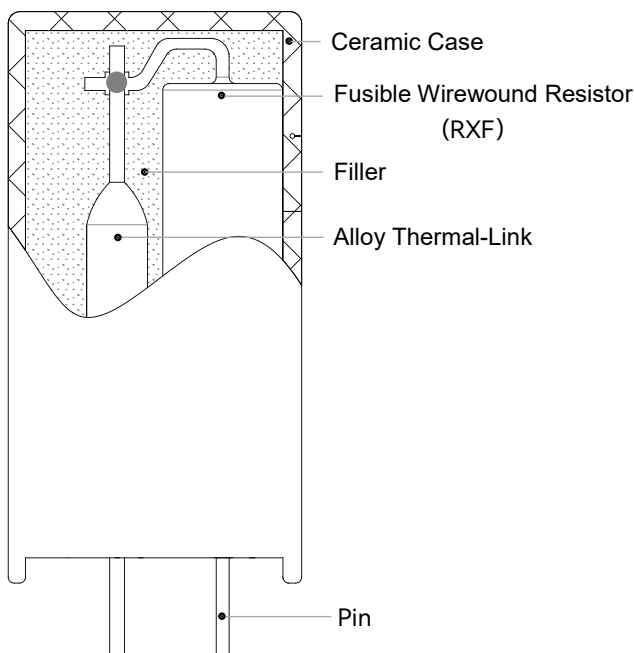

Dimensions (mm)

Vertical

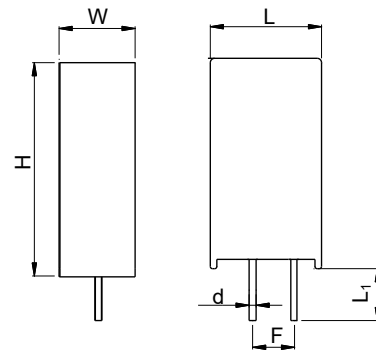

L	W	H	L ₁ ^a	F	d
15.0 ± 1.0	12.0 ± 1.0	32.0 ± 1.5	3.5 ± 0.5	6.0 ± 1.0	Φ0.75 ± 0.08

Horizontal

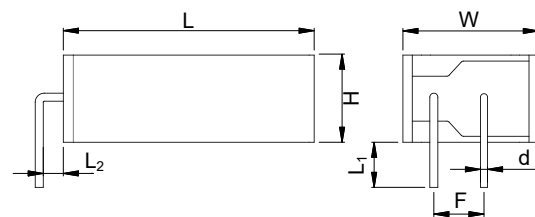

L	W	H	L ₁ ^a	F	d	L ₂
32.0 ± 1.5	15.0 ± 1.0	12.0 ± 1.0	3.5 ± 0.5	6.0 ± 1.0	Φ0.75 ± 0.08	1.5 Max.

Note: a - L₁ can be customized as required from 3.5 mm to 5.0 mm.

TPR

Thermally Protected Resistor

TPR10 Series

Marking

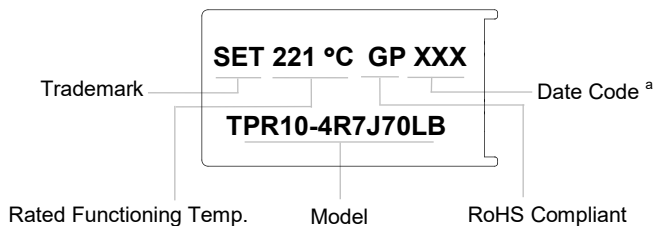

^a: The first XX means production year code, the last X means production quarter code.
eg: "241" means that the production time is the first quarter of Y2024.

Part Numbering System

TPR 10 - 4R7 J 70 L B V - 001

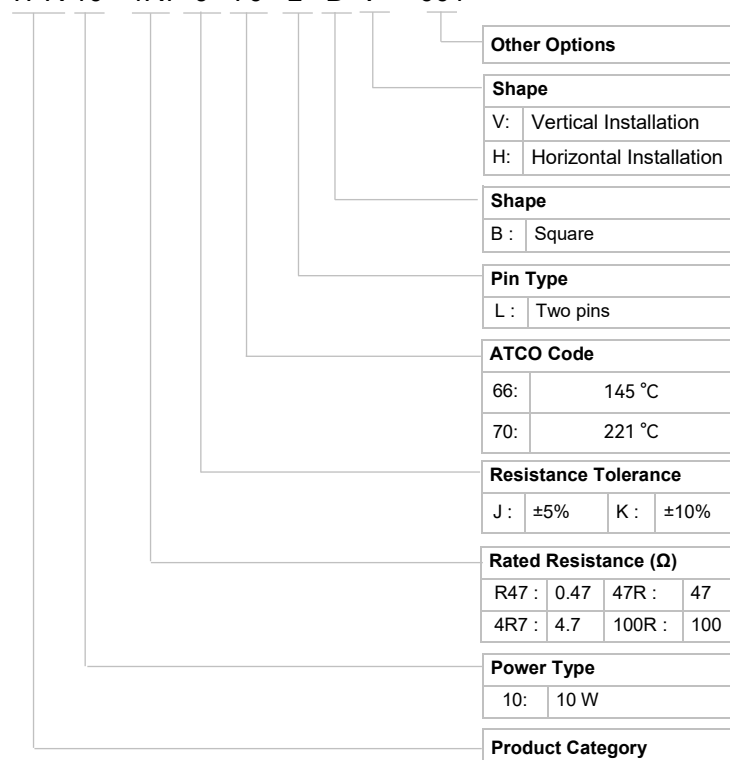

Technical Parameter

Item	Parameter
Power Type (<i>P</i>)	10 W
Rated Resistance (<i>R</i>)	1 Ω ~ 100 Ω
Resistance Tolerance	5% (E24) , 10% (E12)
Derating Factor (<i>f</i>)	See Rated Power Derating Curve
Actual Power (<i>P₀</i>)	$P_0 = P \times f$
Rated Current (<i>I_N</i>)	$I_N = \sqrt{P_0 / R}$
Rated Voltage (<i>U_N</i>)	$U_N = \sqrt{P_0 \times R}$
Fusing Time (less than 60 seconds)	60 W, (<i>T_f</i> = 145 °C) 80 W, (<i>T_f</i> = 221 °C)
Rated Functioning Temp. (<i>T_f</i>)	145 °C, 221 °C
Fusing Temp. (<i>T_f</i>)	See Specifications
Surge (For Reference) Note: Combination Wave	6 kV (<i>R</i> > 10 Ω) 4 kV (<i>R</i> ≤ 10 Ω)

Agency Approvals of ATCO

Code	Model	Rated Functioning Temp. (°C)	Agency Information				
70	C31	221	●	●	N/A	●	N/A
66	C6	145	●	●	●	●	●

TPR

Thermally Protected Resistor

TPR10 Series

Specifications

Model	Power Type	Derating Factor (25 °C)	Rated Functioning Temp. (T _f)	Fuse Temp. (T _F)	Resistance Range (R)	Resistance Tolerance	Environmental Status	
	(W)	(%)	(°C)	(°C)	(Ω)	(%)	RoHS	REACH
TPR10-xxxx70LB	10	70	221	216 ~ 221	1 ~ 100	±5 / ±10	●	●
TPR10-xxxx66LB	10	40	145	138 ~ 145	1 ~ 100	±5 / ±10	●	●

Note: "●" Means certified, RoHS & REACH Compliant. Blue Font Is SETsafe | SETfuse Common Specifications

Resistance Selection Table (According to IEC60063-2015 E24)

Rated Resistance	Code	Rated Resistance	Code	Rated Resistance	Code
(Ω)		(Ω)		(Ω)	
1.0	1R0	5.1	5R1	27	27R
1.1	1R1	5.6	5R6	30	30R
1.2	1R2	6.2	6R2	33	33R
1.3	1R3	6.8	6R8	36	36R
1.5	1R5	7.5	7R5	39	39R
1.6	1R6	8.2	8R2	43	43R
1.8	1R8	9.1	9R1	47	47R
2.0	2R0	10	10R	51	51R
2.2	2R2	11	11R	56	56R
2.4	2R4	12	12R	62	62R
2.7	2R7	13	13R	68	68R
3.0	3R0	15	15R	75	75R
3.3	3R3	16	16R	82	82R
3.6	3R6	18	18R	91	91R
3.9	3R9	20	20R	100	100R
4.3	4R3	22	22R		
4.7	4R7	24	24R		

Fusing Time Curve (For Reference Only)

TPR can open effectively at lower power multiples to protect the circuit timely (ambient temp.: 25 °C ± 2°C).

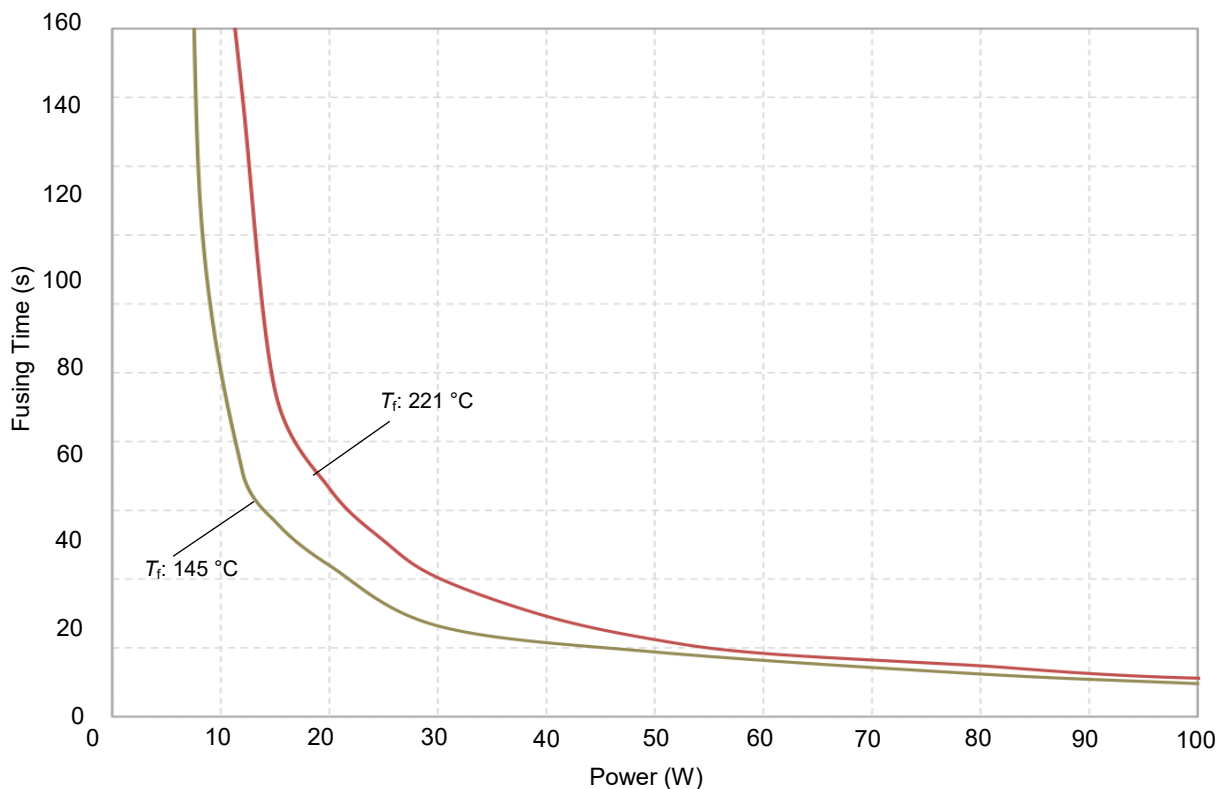

Rated Power Derating Curve (For Reference Only)

When the ambient temp. exceeds 25 °C, the rated power value declines as the following curve.

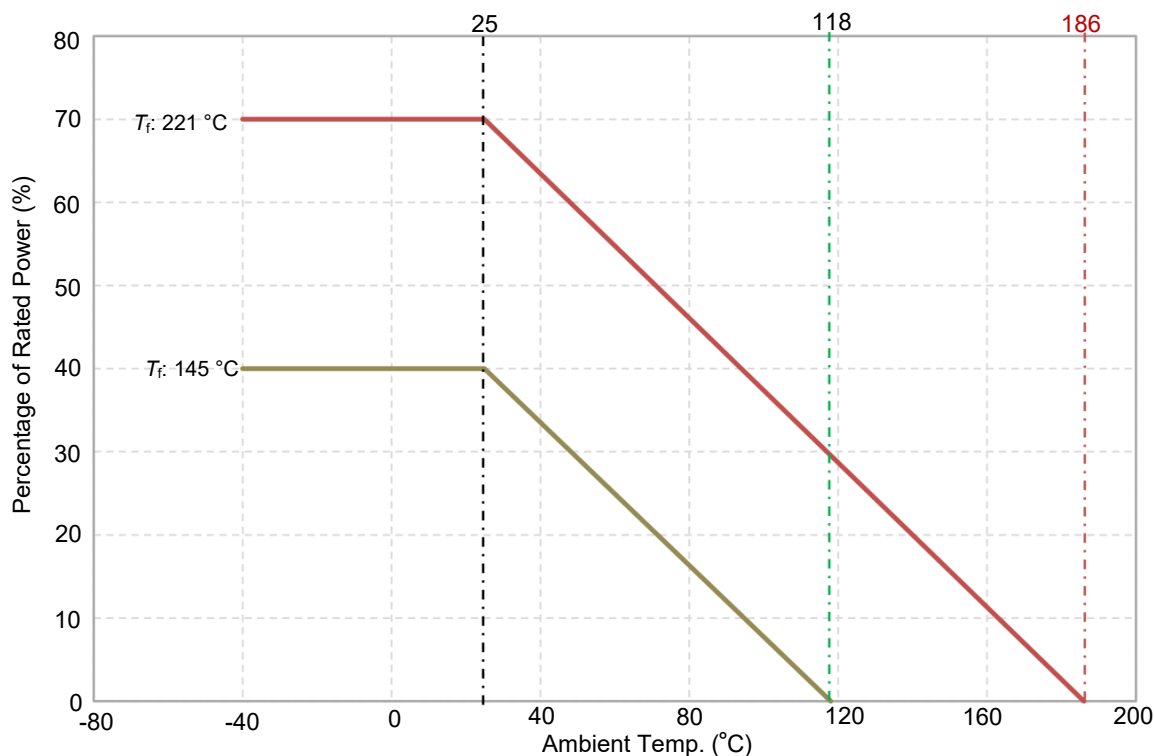

TPR

Thermally Protected Resistor

TPR10 Series

Surface Temp. Curve (For Reference Only)

The surface temp. of TPR is always at a lower level, when small fault current happens to the device, TPR is able to open the circuit timely without additional damage (ambient temp.: 25 °C ± 2 °C).

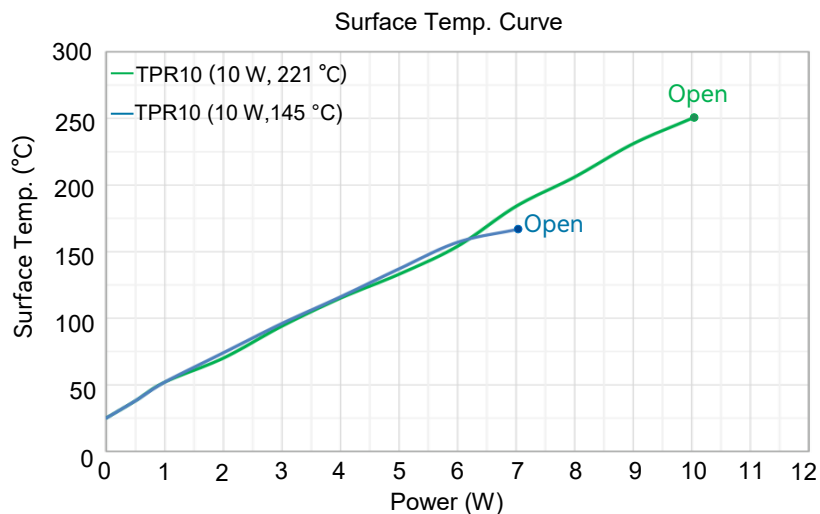

Packaging Information (For Reference Only)

Item	Tray	Carton
Dimension	485 × 320 × 55	495 × 330 × 230
Quantity (PCS)	250	1000
Gross Weight (kg)		13 ± 10%

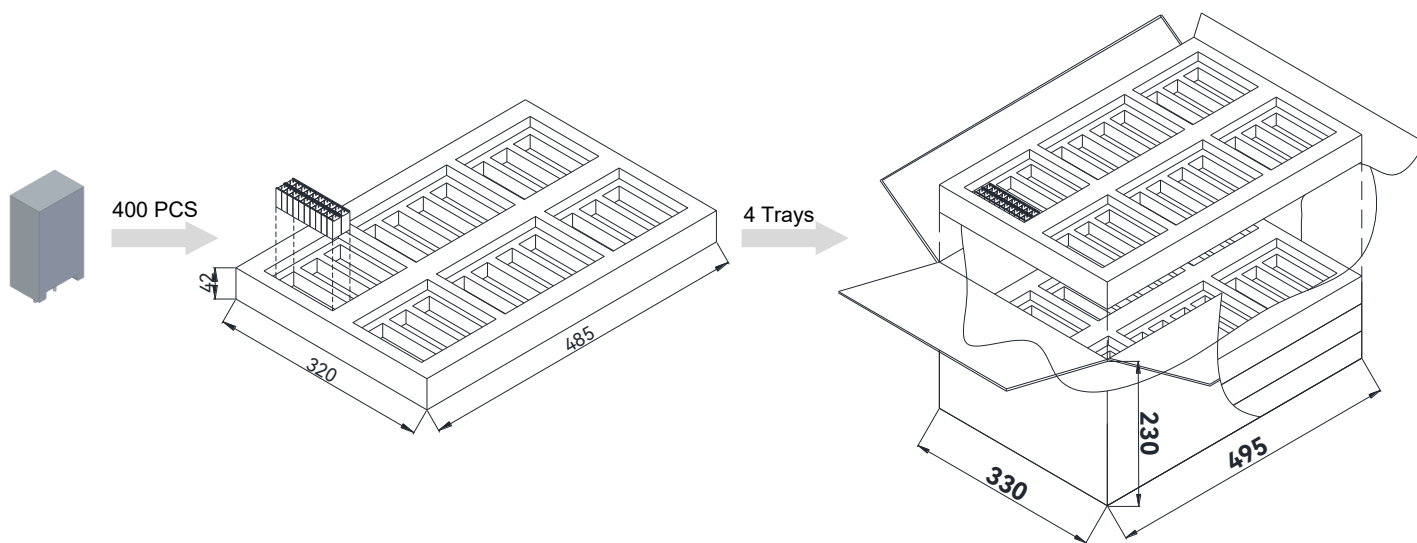

Glossary

Item	Description
RXF	A power resistor which is made by winding a resistive element on a ceramic core, and the core is coated by insulation coating. It intends to interrupt a current flow at a predetermined time when the current exceeds a predetermined value. — (SETsafe SETfuse Standards)
ATCO	Alloy Thermal-Link Alloy Type Thermal-Link, Alloy is the thermal element. — (GB/T 9816.3)
R	Rated Resistance Resistance value for which the resistor has been designed, and which is generally used for denomination of the resistor. — (IEC60115-1)
P ₀	Actual Power The Max. power of TPR can be used within the allowable operating Temp. range. — (SETsafe SETfuse Standards)
I _N	Rated Current $I_N = \sqrt{P_0 / R}$ — (SETsafe SETfuse Standards)
U _N	Rated Voltage The d.c. or a.c. r.m.s. voltage calculated from the square root of the product of the rated resistance and the rated dissipation. — (IEC60115-1)
T _f	Rated Functioning Temp. The temp. of the Alloy Thermal-Link which causes it to change the state of conductivity with a detection current up to 10 mA as the only load. Tolerance: T _f + 0 / -10 °C (GB 9816.1, EN 60691, K60691) Tolerance: T _f ± 7 °C (J60691) — (IEC 60691)
T _F	Fusing Temp. The temp. of the Alloy Thermal-Link which causes it to change its state of conductivity is measured with silicone oil bath in which the temp. is increased at the rate of 0.5 °C to 1 °C / minute, with a detection current up to 10 mA as the only load. — (IEC 60691)
TCR	Temp. Coefficient of Resistance Relative variation of resistance between two given temp. divided by the difference in the temp. producing it. — (IEC60115-1)



ATTENTION

Cold Resistance Test

1. If product TCR is not less than 350 ($10^{-6}/^{\circ}\text{C}$), the measured resistance value shall be corrected as the relative resistance value under 25 °C according to TCR formula.
2. Resistance Measurement (4-terminal test)

Replacement

As TPR is a non-resettable product, for safety sake, please use the same type of TPR for replacement.

Usage

1. Do not touch the resistor body or pins directly when power is on, to avoid burn or electric shock.
2. When air pressure is from 80 kPa to 106 kPa, the relative altitude shall be +2000 m to - 500 m.

Storage

1. Please store TPR with ambient temp. 10 °C ~ 30 °C and relative humidity 30% ~ 75%.
2. Do not store the TPR at the high temp., high humidity or corrosive gas environment, avoid influencing the solderability of the pins, please use them up within 1 year after receiving the goods.

Soldering Parameters

Wave Soldering Parameters (For Reference Only)

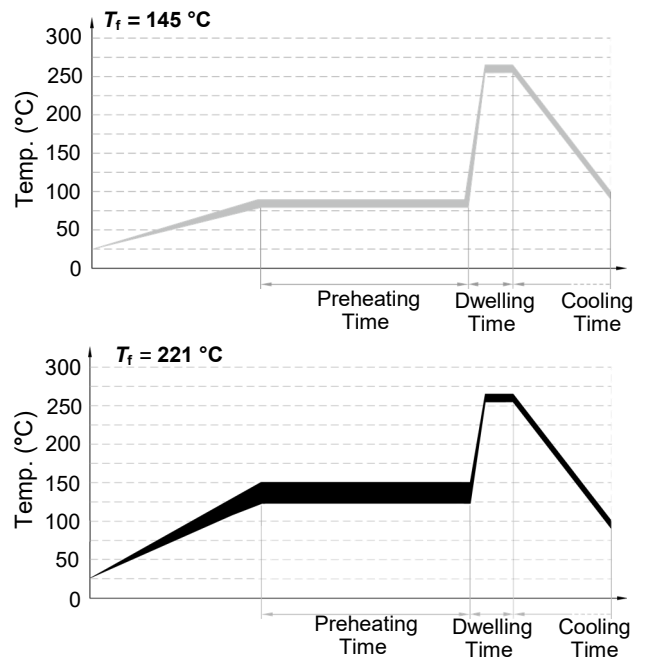



Item	Temp. (°C)		Time (s)
	$T_f = 145^{\circ}\text{C}$	$T_f = 221^{\circ}\text{C}$	
Preheating	80 ~ 90	120 ~ 150	60 ~ 100
Dwelling	260 ± 5	260 ± 5	4 ~ 5

Hand-Soldering Parameters

Solder Iron Temp.: (350 ± 5) °C

Soldering Time: ≤ 5 s ($T_f = 145^{\circ}\text{C}$)
 ≤ 3 s ($T_f = 221^{\circ}\text{C}$)

Thermally Protected Resistor (TPR) Features Overview

Shape						
	Vertical	Horizontal	Vertical	Horizontal	Vertical	Horizontal
Structure	Vertical	Horizontal	Vertical	Horizontal	Vertical	Horizontal
R Resistance Range	(0.27 ~ 800) Ω		(0.27 ~ 1000) Ω		(1 ~ 100) Ω	
	According to IEC60063-2015, resistance can be customized.					
P Power Type	3 W		5 W		10 W	
Dimensions (mm)	11.5 × 7.0 × 20.5	20.5 × 11.5 × 7.0	13.5 × 9.0 × 25.0	27.0 × 14.0 × 9.5	15.0 × 12.0 × 32.0	32.0 × 15.0 × 12.0
	The forming modes and length of lead wires can be customized.					
T_f Rated Functioning Temp.	115 °C, 125 °C, 130 °C, 135 °C, 145 °C, 150 °C, 221 °C				145 °C, 221 °C	